

Pedestrian Access Solutions



Premier Access That Lasts

A photograph of a modern building entrance. In the foreground, a white turnstile stands on a highly reflective, polished floor that mirrors the surrounding environment. To the left, a glass door is partially open, revealing a red circular sign with a white 'no' symbol. The background shows a large glass window and a white structural column. The ceiling is a grid of recessed lighting. A red and blue square graphic is in the top left corner.

Inspired Entrance Solutions

The reliability and options you need
from the pioneers of automatic entrances.

Enter a Better World



You need door systems that offer proven performance and tangible advantages. That's why Horton door systems are built with rugged dependability and available in an almost endless range of styles, finishes and options. Select from a variety of solutions for healthcare, security, retail, hurricane-rated and many other applications.

Horton doors also bring sturdy corner block construction for longevity and superior weather seals for environmental efficiency to your projects. Each system is tested to a minimum of 1,000,000 cycles and is backed by a **two-year warranty**. And our unique design platform makes it easy to obtain custom touches others can't match.

Experience the quality, efficiency, service and custom capabilities of Horton on your next project.

Contact Spec Desk at
1.800.531.3111



Follow us at: www.linkedin.com/company/horton-automatics



Our Other Brands

Excellence Since 1960

Horton Pedestrian Access Solutions is a market leader with a broad range of pedestrian specialty door and access applications under the brands Horton Automatics, FLEX™ by Horton, Door Services Corporation and Won-Door.



Premier Access That Lasts

Creators of the original automatic door and providers of durable, state-of-the-art pedestrian doors for high-performance, sustainable buildings. Designs for healthcare, security, hurricane-rated applications and more.



Quality Access Solutions

Quality access solutions for a variety of applications. Diverse, sensible doors at an optimal price point are engineered with the precision and performance you expect from the industry leader.



Trusted Installation & Services

Trusted experts in pedestrian door service and installation, our factory-authorized distributors provide the professional support you need. Certified AAADM inspectors provide 24/7 service in locations across the U.S.



Fire & Security Solutions

Inventors of the world's most durable, acoustically rated folding partitions and accordion-type, fire-rated horizontal sliding door. Won-Door security and fire solutions offer protection every day in schools, hospitals and other facilities worldwide.

The Horton Difference

EXCLUSIVE

Anti-Warp Door Panel Construction

Commercial-grade heavy-duty rails with integral mortise-style corner block construction for structural integrity and longevity.

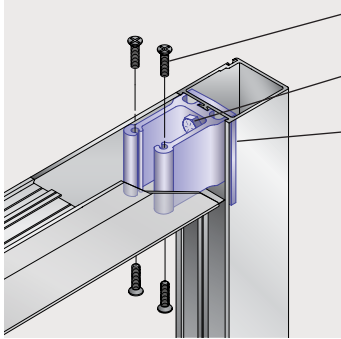

Four #10-24 bolts secure corner block to horizontal rail

Two #1/4-20 bolts secure corner block to vertical rail

Concave steel back-up plate engineered as built-in self locking device for Grade 8 bolts

Compare to mass-produced thru-bolt designs.

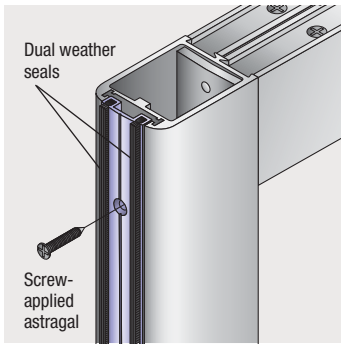

EXCLUSIVE

Tight Double Astragal Weather Seals

Horton's exclusive floating astragal creates a positive seal that stands up to the environment and high traffic. Horton's floating weather seals are permanently captured in the lead rail and screw-applied to the door panels.

Compare to mass-produced adhesive-applied fixed seals.

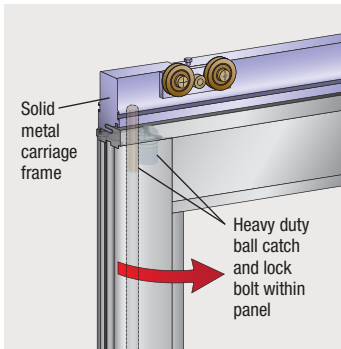

EXCLUSIVE

Self-Latching Breakout Panel

Horton's standard self-latching mechanism brings the panel to the normal operating position without user intervention. Swing breakout panels are reinforced with a solid metal bar with scissor-action to provide support through the full length of the panel.

Compare to mass-produced, non-self-latching, thin wall, shorter-life alternatives.



Custom Finishes Enhance the Aesthetics of Your Design

Horton door systems may be specified with powder coat finishes in a wide range of custom colors including wood grain. Thermally cured for toughness, these earth-friendly PVDF coatings* offer superior durability and color retention, even in the harshest environments. Wet paint and clad finishes are also available.

Also available in brass alloy & stainless steel

*VOC-free, consistent with your LEED objectives



Reliable, aesthetically pleasing access solutions

from the most trusted name in commercial doors.



Custom Solutions

SLIDING DOOR SYSTEMS	6
Profilor®	10
ProSlide®	10
ProfilorStorm®	11
HD-Storm®	11
HD-Storm® Level E	11
Elegant®	12
HD-Slide®	12
Profilor® ICU	13
Profilor® ICU XM	13
ProSlide® Telescoping	14
Profilor® Barn Door	14
FlexBarn™ Barn Door	15
SWING & FOLDING DOOR SYSTEMS	16
HD-Swing®	18
HD-Swing® LE	18
EasyAccess®	19
PowerSwing™ Super Duty	19
ICU Bi-Fold/Bi-Swing™	20
ICU SmokeSwing™ Profilor	20
Acoustic STC-35 ICU SmokeSwing™	21
FoldingAccess®	21
Manual Swing Door	21
ICU STC-35 Swing™	21
REVOLVING DOOR SYSTEMS	22
Grand®	24
MiniGrand®	24
AutoFlow®	25
EasyFlow®	25
EasyFlow® Power Assist	26
Sensors for Revolving Doors	26
SECURITY REVOLVING DOORS	27
ControlFlow®	28
Vidom ELITE®	29
INDUSTRIAL SLIDING DOOR SYSTEMS	30
RapidSlide®	31
HD Slide® Industrial	31
UltraClean® Atmospheric I – ISO 3	32
UltraClean® Atmospheric II – ISO 5	32
UltraClean® Sterile	33
Lead-Lined®	33
ProSlide® Blast	33
PLATFORM SCREEN DOORS	34
SECURE EXIT LANES	35
SERVICE WINDOWS	36
ACTIVATION AND SENSORS	37
DOOR SELECTION TOOLS	38
INSTALLATION AND SERVICE	39

SPECIAL FEATURES



Sliding Door Systems



“Horton Automatics was instrumental in meeting our client’s stringent requirements for design, delivery and quality. Horton’s custom solution resulted in an aesthetically superior and highly functional hospital environment.”

Russ Warrington, President
Automatic Entries, Inc., Lynnwood, WA



Architectural Highlights

- Custom width and height
- Large, clear walk-through opening for good traffic flow
- Minimal spatial footprint
- Egress compliant
- Security options available (see page 37)
- Aesthetic enhances your design
- Special requirements: hurricane rating, ISO class, blast resistance, X-ray, ADA, fire/smoke rating, reduced air infiltration, isolation requirements, and many more.
- Unlimited finish and design options

Comparison

Models	Hospitals / Healthcare / Medical	Grocery & Retail	Upscale Residential & Office	Airports	Hotels/Resorts	Government Facilities	Industrial Manufacturing	Automatic	Manual	General Traffic	High Traffic	Hurricane Rated	All Glass	Trackless	ADA Compliant	Energy Efficiency	ECO Option	Infection Control	Narrow Passageway	Security
Profiler®	•	•	•	•	•	•		•		•					•					
ProSlide® 2021	•	•	•	•	•	•		•		•	•				•	•	•			•
ProSlide® 2003	•	•	•	•	•	•		•		•	•				•					•
HD-Slide®	•	•		•	•	•	•	•			•				•					•
Elegant®	•	•	•	•	•	•		•		•			•		•					
ProSlide® Telescoping	•	•	•	•	•	•		•						•	•				•	
HD-Storm®	•	•		•	•	•		•		•		•			•					
HD-Storm® Level E	•	•		•	•	•		•		•		•			•					
Profiler® Storm	•	•		•		•		•		•		•			•	•				
Profiler® ICU	•								•	•				•	•	•			•	
Profiler® ICU XM	•								•	•				•	•	•			•	
Profiler® Barn Door	•		•		•				•	•				•	•	•				
FlexBarn™	•		•		•				•	•				•	•	•				

MARKETS

FEATURES

The Choice is Yours

Horton Automatics sliding door systems are used in commercial and industrial applications. Systems starting at 7' unit widths. Door configurations are offered in 2-, 3-, 4- or 6-panel designs with choice of anodized aluminum, paint or metal clad finishes. Narrow, medium and wide stile panels and all-glass Elegant® designs are also available.





Door Types

Consult factory for other options

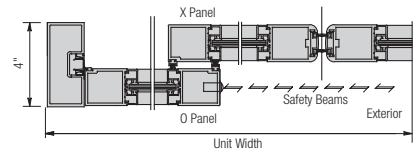

Type 010 (No swing capability)
Doors slide to interior of fixed sidelites.

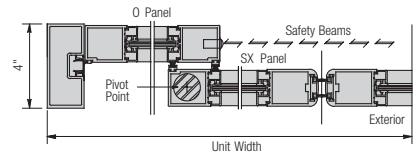

Type 110 (Moving panels swing out)
Doors slide to the exterior of fixed sidelites.

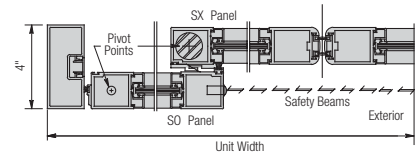

Type 310 (All panels swing out)
Largest breakout area for moving wide objects.
Doors slide to the interior of fixed sidelites.

Ultimate Dependability

At the heart of these hardworking systems is a choice of Horton Automatics sliding door operators. Each features a microprocessor control and digital display for visual adjustment of settings and diagnostics. An auto-seal feature ensures the doors are closed for energy savings.

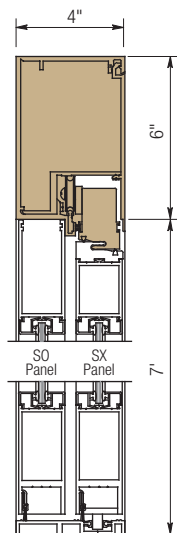

Series 2000B

Elite Belt Drive System

- Panels up to 250 lbs
- Compact design for superior aesthetics
- Supplied with Profiler® and Profiler® Storm systems
- Durable 4" x 6" header
- Header flush to jambs

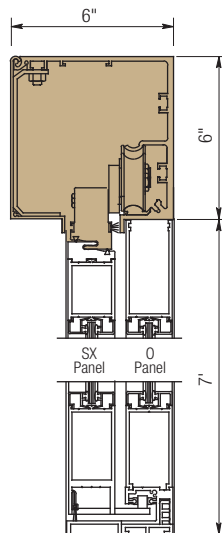

Series 2003

Belt Drive System

- Panels up to 250 lbs
- Heavy-duty drivetrain with 1/8 HP motor
- Durable 6" x 6" header
- Header flush to jambs

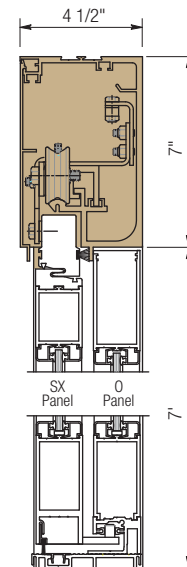

Series 2021

Heavy Duty 1/8 HP Belt Drive System

- Panels up to 250 lbs
- Supplied with ProSlide UltraClean I
- EPD available
- ECO-U factor option
- Header flush to jambs

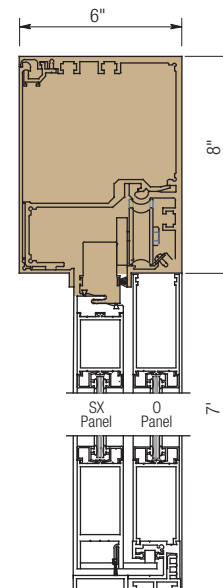

Series 2001

Optional 1/4 HP Belt Drive System

- Heaviest panels to 300 lbs (bi-part) or 500 lbs (single slide)
- Supplied with HD-Storm®, HD-Slide®, Elegant®, RapidSlide™ and Industrial
- Heavy Duty 6" x 8" header
- Header flush to jambs

Sliding Door Systems



Profiler® Series 2000

High Traffic: Best Selling Automatic Slide

Belt Drive, Header Size 4" x 6"

This system allows for flush-mounted solutions to jambs without end caps. The Series 2000 system is often selected for its visual appeal, yet the real advantage is its dependability, with fewer parts to wear and easy adjustments.

Applications

- Healthcare
- Upscale residential & offices
- Retail
- Schools
- Government
- Hotels/resorts
- Commercial



ProSlide® Series 2021

High Traffic: ISO 3 – ISO 9 Specifiable

Belt Drive, Header Size 4.5" x 7"

This heavy-duty system is engineered for long life and quiet operation in high traffic applications. It can be specified as ISO 3 - ISO 9 cleanroom compliant without the need for vacuum systems and is available in an ECO/U-Factor option for energy efficiency and LEED certification. Verified by SCS Global Services for its Environmental Product Declaration.

Applications

- Airports
- Healthcare
- High-rise residential
- Supermarkets
- Schools
- Government
- Shopping malls
- Hotels/resorts
- Commercial

ProSlide® Series 2003

High Traffic

Belt Drive, Header Size 6" x 6"

The ProSlide® Series 2003 is a robust system capable of handling door panels up to 250 lbs. Engineered for durability with a 6" tall by 6" wide header, the Series 2003 heavy-duty door system is designed for longevity and quiet operation in commercial applications.

Common Features for both Profiler® and ProSlide®

- Custom manufactured to your specifications
- Advanced microprocessor controls with built-in diagnostics
- Up to 84" clear opening



Exterior Elevations Plans for both Profiler® and ProSlide®

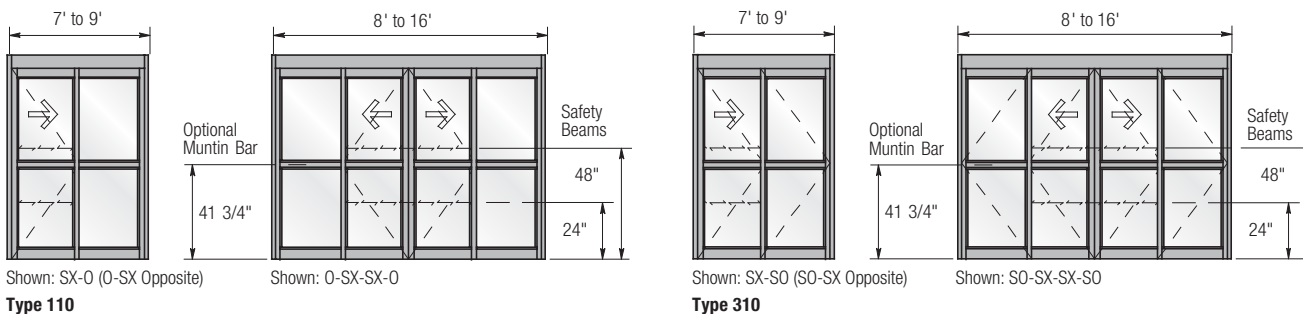

Selection Guide

Model	Type	Unit Width	Max. Clear Opening	Type 110 Breakout Opening	Type 310 Breakout Opening
Profiler® & ProSlide® 2003	Single	7' to 9' (2134–2743)	3' to 4' (914–1219)	3' 3/4" to 4' 3/4" (1003–1308)	6' 3" to 8' 3" (1905–2515)
	Bi-Parting	8' to 16' (2438–4877)	3' to 7' (914–2134)	3' 7" to 7' 7" (1092–2311)	6' 9/2" to 14' 9/2" (2070–4509)
ProSlide® 2021	Single	7' to 9' (2134–2743)	2' 11/4" to 3' 11/4" (980–1213)	3' 3/4" to 4' 3/4" (997–1302)	6' 4" to 8' 4" (1930–2540)
	Bi-Parting	8' to 16' (2438–4877)	3' 1/2" to 7' 1/2" (953–2172)	3' 1/2" to 7' 1/2" (953–2172)	6' 11/2" to 14' 11/2" (2121–4559)



ProfilerStorm® Series 2000

Storm & Hurricane Rated

±55 PSF

An industry standard for Miami-Dade compliance, the ProfilerStorm® Series offers multiple specifiable options, making it ideal for any application. Available with panic devices. Level D impact rating.

Glass Options

- Large missile
- Small missile
- Non-impact

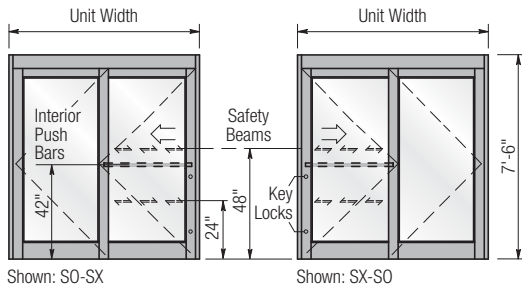

Shown: SO-SX

Shown: SX-SO

Type 310

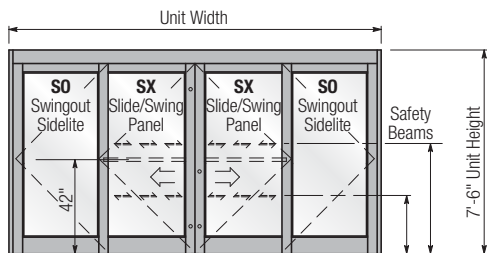

Shown: SO-SX-SX-SO

Type 310



HD-Storm® Level E Series 2001

Highest Hurricane Rating

±80 PSF

Offering the largest envelope and 3-point locking, this system offers the ultimate protection against high winds and windborne debris. Compliant with Florida Building Code 2020 Miami-Dade NOA. Level E impact rating.

Glass Options

- Large missile
- Small missile
- Non-impact

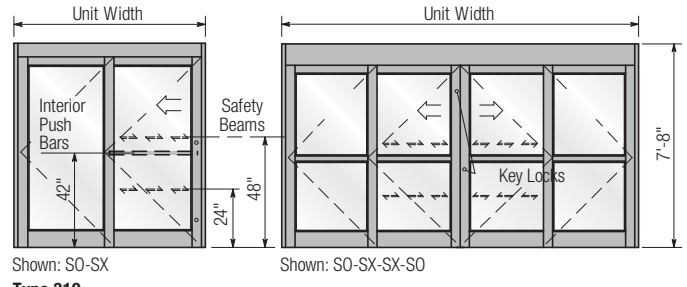

Shown: SO-SX

Shown: SO-SX-SX-SO

Type 310

HD-Storm® Series 2001

Storm & Hurricane Rated

±70–85 PSF

Highest pounds per square foot (PSF) rating with rugged corner block construction and steel reinforced rails. 3-point locking system ensures the entrance is anchored when the door isn't in use. Specify in healthcare facilities, office buildings, home improvement centers, grocery and retail stores, and wherever superior storm protection is needed.

- 70-85 PSF
- Miami-Dade approved
- HD 6" x 8" header
- Large missile
- Small missile
- Non-impact
- Panic hardware with auto lock for 85 PSF bi-parting doors



Selection Guide						
Model	Type	Unit Width	Max. Clear Opening	Type 110 Breakout Opening	Type 310 Breakout Opening	
ProfilerStorm®	Single	7' to 8' (2134–2438)	2' 10½" to 3' 4½" (876–1028)	3' 3¼" to 3' 9¼" (997–1149)	6' 3" to 7' 3" (1905–2210)	
	Bi-Parting	8' to 16' (2438–4877)	2' 9½" to 6' 9½" (851–2070)	3' 7" to 7' 7" (1092–2311)	6' 9½" to 14' 9½" (2070–4509)	
HD-Storm® Level E	Single	7' to 8' (2134–2438)	2' 9¼" to 3' 9¼" (845–1149)		6' 3" to 8' 3" (1905–2515)	
	Bi-Parting	8' to 16' (2438–4877)	2' 9½" to 6' 9½" (851–2070)		6' 9½" to 14' 9½" (2070–4509)	
HD-Storm®	Single	7' to 9' (2134–2743)	2' 9¼" to 3' 9¼" (845–1149)	3' 2½" (987)	6' 3" to 8' 3" (1905–2515)	
	Bi-Parting	10' to 14' (3048–4267)	3' 11¼" to 5' 11¼" (1200–1810)	4' 8¼" to 6' 8¼" (1441–2051)	8' 9½" to 12' 9½" (2680–3899)	

Sliding Door Systems



Elegant® Series 2500

General Traffic: All Glass System

With frameless styling, the Elegant® door system showcases your building's inner beauty while offering energy efficiency. Available with panic devices.

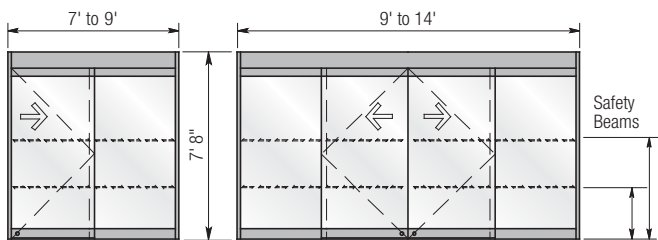

Shown: SX-0 (O-SX Opposite) Shown: O-SX-SX-0

Type 110

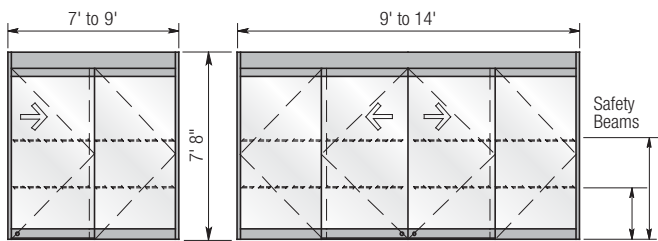

Shown: SX-S0 (S0-SX Opposite) Shown: S0-SX-SX-S0

Type 310



HD-Slide® Series 2001

Heavy Duty Belt Drive System

Developed for use with large commercial and industrial doors up to 500 lbs, this system is engineered with a high-capacity header, heavy-duty powertrain and breakouts. An optional ¼ HP motor is available to accommodate extreme requirements.

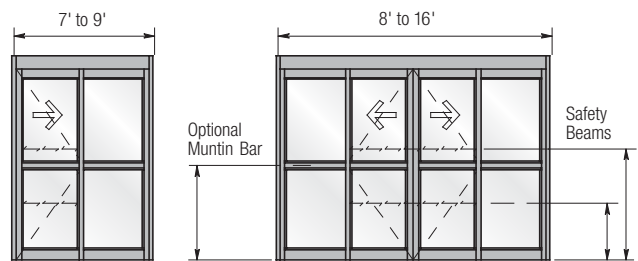

Shown: SX-0 (O-SX Opposite) Shown: O-SX-SX-0

Type 110

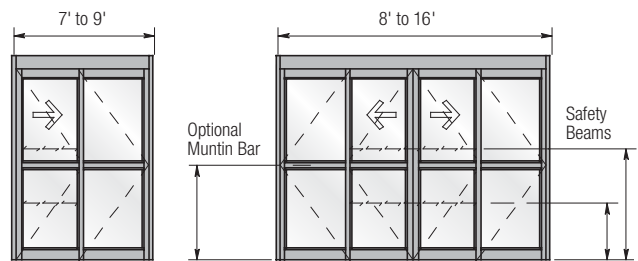

Shown: SX-S0 (S0-SX Opposite) Shown: S0-SX-SX-S0

Type 310

Selection Guide						
Model	Type	Unit Width	Max. Clear Opening	Type 110 Breakout Opening	Type 310 Breakout Opening	
Elegant®	Single	7' to 9' (2134–2743)	3' to 4' (914–1219)	3' 1¼" to 4' 1½" (959–1264)	6' 3" to 8' 3" (1905–2515)	
	Bi-Parting	9' to 14' (2743–4267)	3' 6" to 6' (1067–1829)	3' 10" to 6' 4" (1168–1930)	7' 9½" to 12' 9½" (2375–3899)	
HD-Slide®	Single	7' to 9' (2134–2743)	2' 10¼" to 3' 10¼" (883–1187)	3' 3½" to 4' 3½" (1003–1308)	6' 3" to 8' 3" (1905–2515)	
	Bi-Parting	8' to 16' (2438–4877)	3' to 7' (914–2134)	3' 7" to 7' 7" (1092–2311)	6' 9½" to 14' 9½" (2070–4509)	



Profiler® ICU

ICU Patient Room Doors

Manual & Self-Closing Sliding Doors
Exceeds the requirements of NFPA 105 per UL 1784. Modified door nosings, bottom rails and interlock seals exceed smoke infiltration requirements of NFPA 105.



- ISO 3 – ISO 9 specifiable
- Concealed high-temperature gasket or brush design
- Positive latching
- Available in trackless configurations
- Self-closing mechanism available
- UL 1784 smoke-rated
- Offered in single (1- or 2-panel) or single telescopic (3-panel)

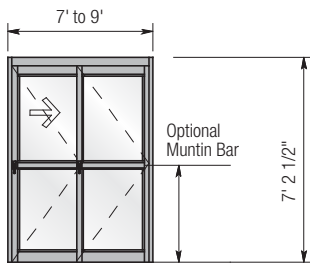

Shown: SX-SO (SO-SX Opposite)

Type 310

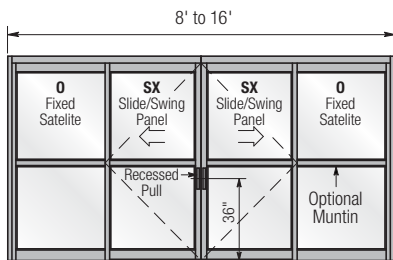

Shown: SO-SX-SX-SO

Type 310



Profiler® ICU XM

Largest Clear Opening in the Industry

Manual & Self-Closing Sliding Doors
Designed for ICU and other critical care environments, these multi-function doors keep patients in full view when doors are closed. The panels swing out to provide maximum clearance for beds and equipment.



- ISO 3 – ISO 9 specifiable
- Trackless design option for unobstructed mobility and superior hygiene
- Self-closing mechanism available
- Multiple privacy-glass options available
- UL 1784 smoke-rated



Allows clear monitoring of the room and full breakaway to move patients.

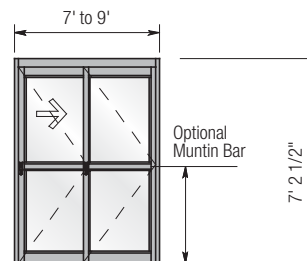

Shown: SX-SO (SO-SX Opposite)

Type 310

Selection Guide

Model	Type	Unit Width	Max. Clear Opening	Breakout Opening Type 310
Profiler® ICU	Single	7' to 9' (2134–2743)	3' 1" to 4' (940–1219)	6' 3" to 8' 3" (1905–2515)
Profiler® ICU XM	Single	7' to 9' (2134–2743)	3' 1" to 4' 1/8" (940–1241)	6' 3" to 8' 3" (1905–2515)

Sliding Door Systems



ProSlide® Telescoping Series 2003T

General Traffic: Maximum Opening

Ideal for automatic sliding door access in narrow passageways, effectively increasing the opening width more than 35 percent. Available in single or bi-parting configurations.



Applications

- Healthcare
- Hotels/resorts
- Shopping malls
- Office buildings

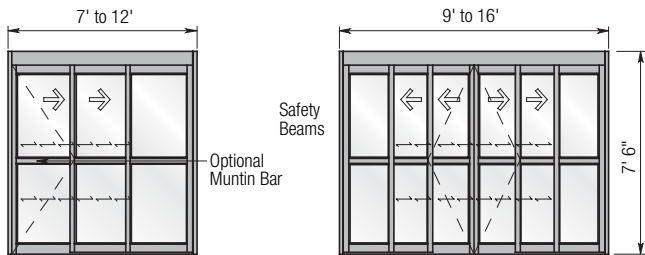

Shown: SX-X-0 (O-X-SX Opposite)
Type 110

Shown: O-X-SX-SX-X-0

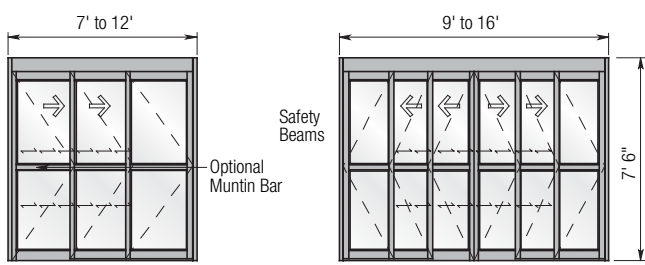

Shown: SX-SX-SO (SO-SX-SX Opposite)
Type 310

Shown: SO-SX-SX-SX-SX-SO



Profiler® Barn Door

Manual Glass Sliding Door

This stylish barn door system offers the popular barn door design while meeting compliance codes including UL 1784 Smoke Rating, which sets the standard for healthcare and office applications.

- Eliminates the need of a threshold
- Spring closing or power open/close
- Manual operation – low open/close force of 5 lbs or less
- 1-, 2-, 3- and 4-panel configurations
- Oversized panel available
- Available in smoke-rated or non-smoke rated

Applications

- Patient rooms
- Exam and treatment rooms
- Patient toilet room
- Offices
- Laboratories
- Equipment rooms
- Healthcare

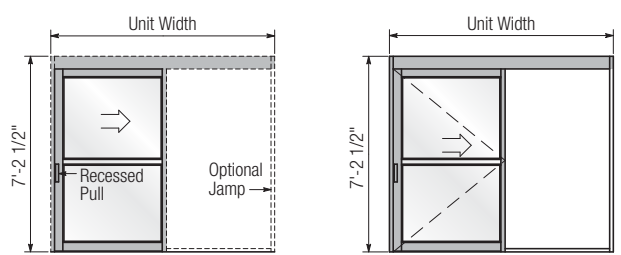

Shown: X-P (P-X Opposite)
Type 010

Shown: SX-P (P-SX Opposite)
Type 110

Selection Guide							
Model	Slide Type	Unit Width	Max. Clear Opening	Min Slide Opening	Max Slide Opening	Type 110 Breakout Opening	Type 130 Breakout Opening
ProSlide® Telescoping	Single	7' to 12' (2134–3658)	3' 7½" to 6' 11½" (1105–2121)	–	–	2' 1¼" to 3' 9¼" (641–1149)	6' 1" to 11' 1" (1854–3378)
	Bi-Parting	9' to 18' (2743–5486)	4' 1½" to 10' 1½" (1257–3086)	–	–	2' 7½" to 5' 7½" (800–1651)	7' 5" to 16' 5" (2261–5004)
Profiler® Barn Door	Single	7' to 9' (2134–2743)	–	2' 10½" (876)	3' 10½" (1181)		
	Bi-Parting	8' to 16' (2438–4877)	–	2' 10½" (876)	6' 10½" (2096)		



FlexBarn™ Barn Door

Surface-Applied Multi-Use

Manual Sliding Door System

Ideal for everyday use, the attractive FlexBarn™ features ADA-compliant hardware, trackless design and a soft close/soft open dampening system for seamless operation and unobstructed access.

- Available in antimicrobial aluminum door & frame system
- Available in wood species solid core lumber and plastic laminate and a variety of glass options
- Broad range of glazing selections
- Unlimited finish options
- Available in smoke-rated UL 1784

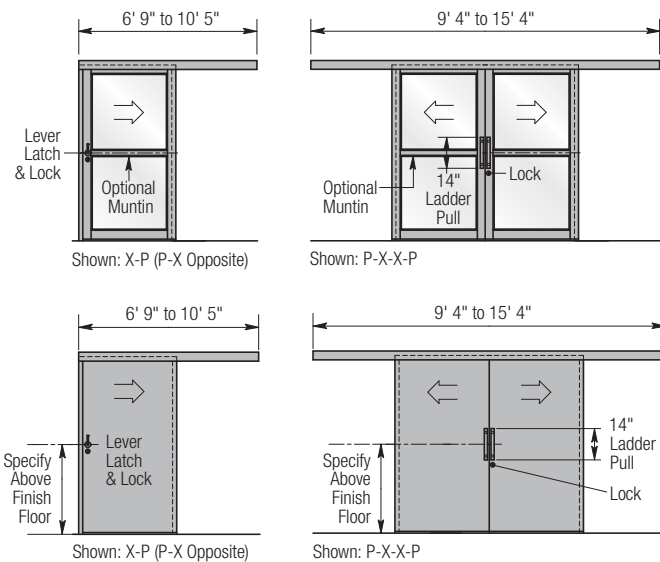

Project: Lancaster General Emergency Department

“There was a delay in the summer due to material procurement that could have been a major blow to the project opening date. Horton’s team, in combination with Susquehanna Door Service’s team, did a good job of recovering from the material procurement issue. They mobilized quickly and communicated throughout the entire process to ultimately get the materials we needed installed prior to the opening date. Every project has issues, but it’s how a vendor handles them that gives you confidence that you chose the right vendor. And I’m confident that we did.”

Scott McDowel, Project Manager
Zephyr Aluminum



Follow us on LinkedIn for more project highlights.
www.linkedin.com/company/horton-automatics

Selection Guide

Model	Slide Type	Unit Width	Max Clear Opening	Slide Panel Width
FlexBarn™	Single	6' 9" to 9' 5" (2057-2870)	3' to 4' 4" (914-1321)	3' 6½" to 4' 10½" (1080-1499)
	Bi-Parting	9' 4" to 15' 4" (1080-1499)	4' to 7' (1219-2134)	2' 6" to 4' (762-1219)

Swing & Folding Door Systems



Where Form Meets Function

Choose from a beautiful, full range of swing and folding door systems that provide access solutions for new construction or an existing building.

Architectural Highlights

- Actuation: manual, sensor or knowing act
- Aesthetics: surface applied, overhead concealed
- Finishes: material, color
- Code Compliance: ANSI 156.10, 156.19 (ADA)
- Fire and safety requirements

Comparison

Models	Hospitals/ Healthcare/ Medical	Grocery & Retail	Upscale Residential & Office	Airports	Schools	Hotels/ Resorts	Government Facilities	Industrial Manufacturing	Automatic	Manual	General Traffic	Trained Traffic	ADA Compliant	Full Power	Low Energy	Fire Rated	Smoke Rated	Air Leakage Tested	Safety Sensors	Touchless/Push Activation
HD-Swing®	•	•	•			•	•	•	•		•	•	•	•	□	□			□	□
HD-Swing® LE	•	•		•		•					•	•	•		•	□			□	□
EasyAccess®	•								•		•	•	•		•	□			□	□
PowerSwing™ Super Duty	•								•			•							•	□
ICU Bi-Fold/Bi-Swing™	•	•	•		•		•			•	•	•	•				•	•		
Profiler® ICU SmokeSwing™	•	•	•		•		•			•	•	•	•				•	•		
Acoustic STC-35 ICU SmokeSwing™									•		•						•	•		
FoldingAccess®	•	•	•		•		•		•	•	•	•							•	□
Manual Swing Door	•		•			•				•	•	•	•							
	MARKETS								FEATURES											

□ Optional



Custom finishes available.

Horton heavy-duty swing door operators come in two basic styles: Surface Mounted and Overhead Concealed. "Side Load," "Bottom Load" and "Full Access" mounting options refer to the direction in which access is made for installation and maintenance.

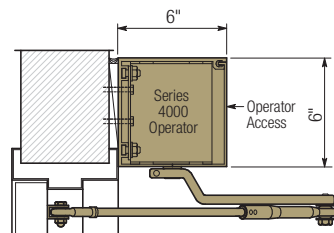

Series 4100 Side Access
with Outswing Arm Assembly

**Series 4100
Series 7100
Operator Features**

- Single, pair or double egress door operation
- Adjustable opening and closing speeds
- Push-N-Go® activation
- Obstruction sensing reduces opening speed when obstructed
- Fire-rated options available
- Choice of in-swing, out-swing, left or right-handed operation

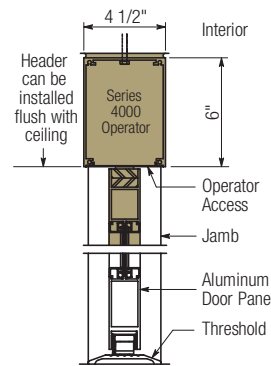

Series 4500 Bottom Access
Direct Drive

**Series 4500
Complete Swing Door and
Frame System**

**Series 4800
Overhead Concealed Header Operator**

- Single, pair or double egress door operation
- Choice of in-swing, out-swing, left or right-handed operation
- Available overhead concealed package complete with door and frame or door by other
- Header with bottom or side access

Swing & Folding Door Systems



HD-Swing® Series 4100 Heavy Duty Universal Operator

Choice of header models for surface applied or overhead concealed installations.

- Simple adjustments for full energy (automatic) or low energy (handicap accessible)
- Single acting spring always returns door to closed position, with adjustable speed and force
- Available as a fire-rated operator: HD Swing Series 4900

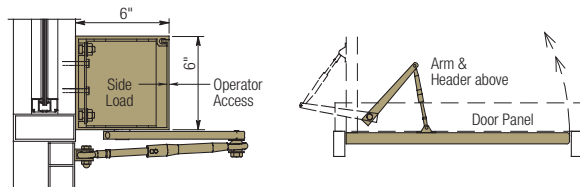

Standard 6" x 6" Header
with Standard In-swing Arm Assembly

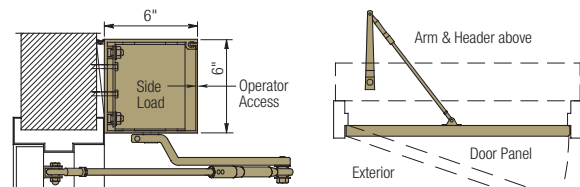

Optional 6" x 6" Header
with Out-swing Arm Assembly

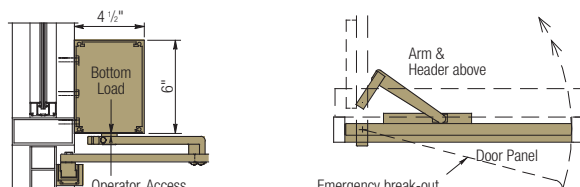

Optional 4 1/2" x 6" Header
with Parallel In-swing Arm Assembly

Surface Applied Operator Configurations

Selection Guide			
Model	Type	Unit Width	Header Width
HD-Swing®	Single	3' to 4' 6" (914-1372)	3' 3" to 4' 3" (991-1295)
	Pair	6' to 8' (1524-2134)	6' 3" to 8' 3" (1600-2210)
HD-Swing® LE	Single	3' to 4' 6" (914-1372)	3' 3" to 4' 3" (991-1295)
	Pair	6' to 8' (1524-2134)	6' 3" to 8' 3" (1600-2210)



HD-Swing® LE Series 4100LE Industry Standard For Heavy Duty, Low Energy Applications

Low Energy ADA Compliant, Heavy Duty Operator

Ideal for use with large, heavy doors required to meet ADA and ANSI A117.1 and A156.19 as well as high traffic environments.



- Easy switching to full power (automatic) operation
- Choice of in-swing or out-swing
- Surface applied or overhead concealed mounting
- Activated by "knowing act"
- Available in 4 1/2" x 6" bottom access or 6" x 6" side access header

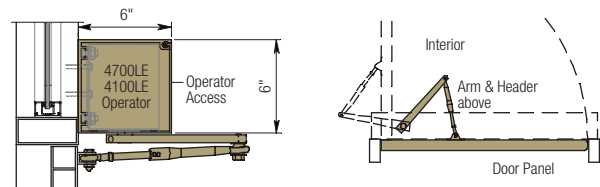

Standard 6" x 6" Header
with Standard In-swing Arm Assembly

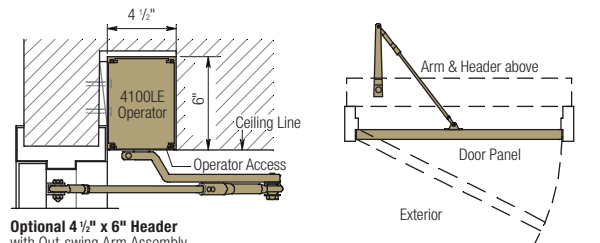

Optional 4 1/2" x 6" Header
with Out-swing Arm Assembly

Surface Applied Operator Configurations

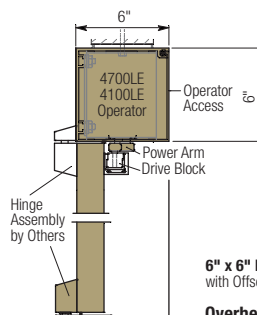

6" x 6" Header
with Offset Arm Assembly

Overhead Concealed Side Access with Offset Arm Assembly



EasyAccess® Series 7100

Contactless Activation Compatible

Low Energy Operator

The EasyAccess® operator is ideal for new or converted barrier-free openings per ANSI A117.1 and A156.19. Available as fire-rated operator EasyAccess® Series 7900.



- Automatic opening with knowing act activation
- Easily adjustable opening and closing speeds
- Surface-applied mounting
- Push-N-Go® feature, SoftTouch® reversing and obstruction sensing
- Available in 4" x 6" or 6" x 6" side access headers

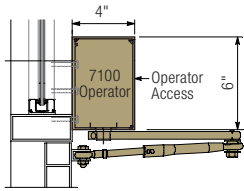

Standard 4" x 6" Header
with Standard In-swing Arm Assembly

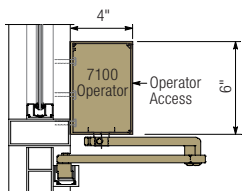

Standard 4" x 6" Header
with Parallel In-swing Arm Assembly

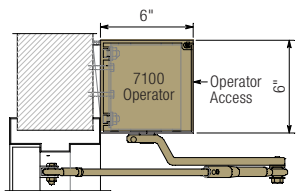

Optional 6" x 6" Header
with Out-swing Arm Assembly

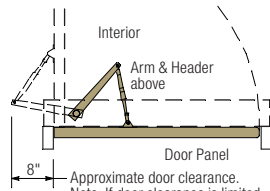

Interior
Arm & Header above
Door Panel
8" Approximate door clearance.
Note: If door clearance is limited use Parallel Arm.

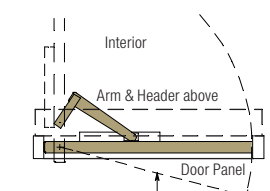

Emergency Break-out feature for center pivoted door panels.

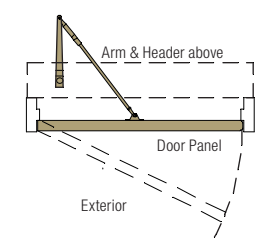

Exterior

Surface Applied Operator Configurations

Selection Guide

Model	Type	Unit Width	Header Width
EasyAccess®	Single	3' to 3' 6" (914-1067)	3' 3" to 3' 9" (991-1143)
	Pair	6' to 8' (1524-2134)	5' 3" to 7' 3" (1600-2210)
PowerSwing™ Super Duty	Single	-	3' 9" (1143) min.
	Pair	-	7' 6" (2286) min.



PowerSwing™ Super Duty Series 4700

High Traffic Swing Door Operator

The Series 4700 Super Duty is capable of opening and closing doors weighing several thousand pounds such as industrial door panels and hospital X-ray door panels. Typically, these very heavy doors are balanced and equipped with precision hinges which significantly reduce opening and closing force. Available with "knowing act" activation.

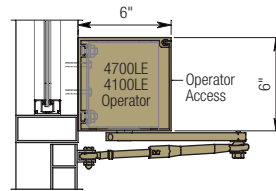

Standard 6" x 6" Header
with Standard In-swing Arm Assembly

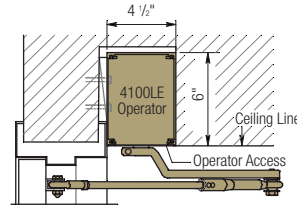
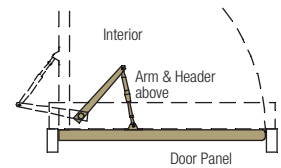

Optional 4 1/2" x 6" Header
with Out-swing Arm Assembly

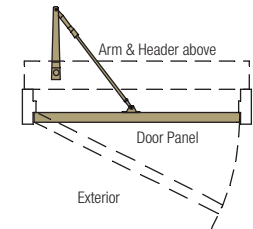

Surface Applied Operator Configurations

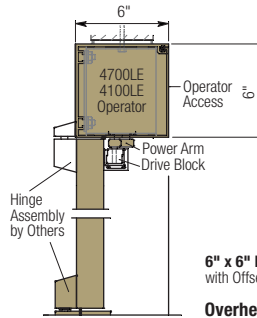

6" x 6" Header
with Offset Arm Assembly

Overhead Concealed Side Access with Offset Arm Assembly

Swing & Folding Door Systems



ICU Bi-Fold/Bi-Swing™

Extra Wide Access

2-in-1 System for Wide, Unobstructed Access

Versatile access of a swing door for normal two-way traffic and an adjacent bi-fold door dramatically increases the opening up to 6' 8" when moving patients or medical equipment.



Bi-Swing Door opens conveniently in both directions for normal traffic.



Bi-Fold Door creates additional clearance for patient and equipment moves.

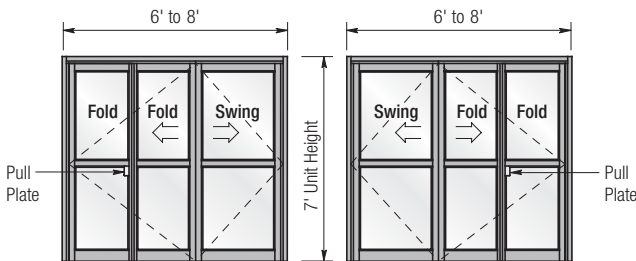

Profiler® ICU SmokeSwing™

Manual Swing Door System

This manual swing system is offered in equal and unequal pair configurations. Available in sizes from 39 1/2" to 99 1/2" with up to 91" of clear opening area. These systems can be specified with mini-blind glass and/or fire-rated panel options. Compliant with UL 1784 smoke rating.

- Positive latching handles for added safety and superior smoke seal
- Concealed high temperature weather strip and gasket design
- Available in single, equal pair and unequal pair widths up to 48" per leaf

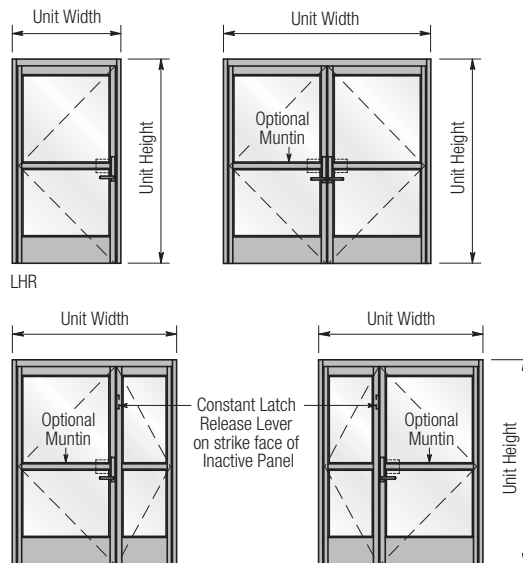

Selection Guide					
Model	Type	Unit Width	Max Clear Opening	Max Breakout Opening	
ICU Bi-Fold/Bi Swing™	Swing/Folding	6' to 8' (1829-2438)	4' 8" to 6' 8" (1422-2032)	4' 11" to 6' 11" (1499-2108)	
Profiler® ICU SmokeSwing™ Doors	Single	3' 3/2" to 4' 3/2" (1003-1308)	2' 11/4" to 3' 11/4" (895-1200)	—	
	Unequal	5' 3/2" to 6' 3/2" (1613-1918)	4' 7" to 5' 7" (1397-1702)	—	
	Equal	6' 3/2" to 8' 3/2" (1918-2527)	5' 7" to 7' 7" (1524-2134)	—	



Acoustic STC-35 ICU SmokeSwing™

Smoke-Rated Manual Door

The ICU STC-35 Swing™ Door is intended primarily for interior use in the ICU and CCU. The STC-35 manual swing door features wide glass panels for unobstructed viewing of patients and an ADA-compliant handle.

Available in single, equal pair and unequal pair.



Compliant with:

- STC35 Sound Transmission Class (rating)
- ASTM E413-04: rating sound insulation
- ASTM E90-4: airborne sound transmission loss



Improved handle design (ADA-compliant) with easy-to-operate handle.

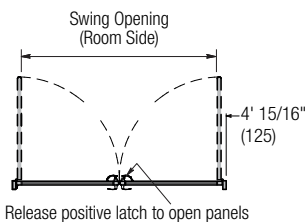
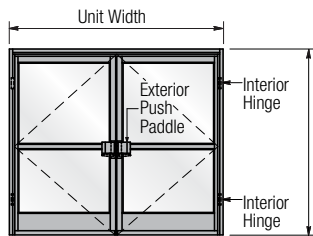

FoldingAccess®

Narrow Corridor Folding Door

Ideal for vestibules and corridors that require wide openings in a narrow hallway. The system may also be specified for manual operation. Available with magnetic lock and panic hardware.



- Emergency breakout
- Finger guard at all hinge points
- Accommodates one-way or two-way traffic
- Also available in manual opening styles for ICU applications
- Sensor choices available on page 37

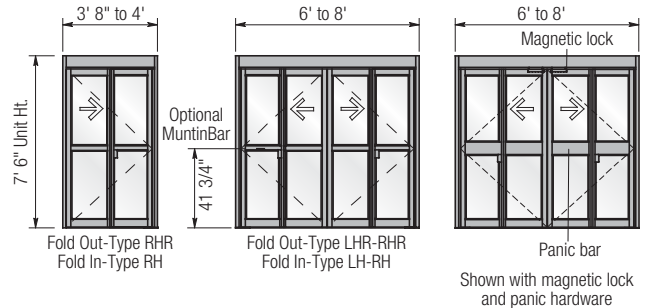

Manual Swing Door Series 0500

ADA Compliant Manual Doors

Package includes overhead concealed hydraulic closer with frame and center-pivoted doors. Doors are double-acting and can be right or left hand. This package is often used in multiple door installations where a manual swing door is located next to automatic sliding or revolving doors.

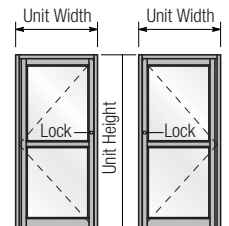

Selection Guide					
Model	Type	Unit Width	Panel Width	Max Clear Opening Swing Opening	Max Breakout Opening Rough Opening Width
Acoustic STC-35 ICU SmokeSwing™	Unequal	5' 3" to 6' 3" (1613-1918)	3' 4" (914-1219)	4' 5" to 5' 5" (1362-1667)	5' 4" to 6' 4" (1626-1930)
	Equal	6' 3" to 8' 3" (1918-2527)	3' 4" (914-1219)	5' 5" to 7' 5" (1667-2276)	6' 4" to 8' 4" (1829-2540)
	Single	3' 4" to 4' 4" (1016-1321)	3' 4" (914-1219)	2' 8" to 3' 8" (822-1127)	3' 4" to 4' 4" (1029-1334)
FoldingAccess®	Single	3' 8" to 4" (1118-1219)	—	2' 8" to 3' (813-914)	2' 11" to 3' 3" (889-991)
	Pair	6' to 8" (1829-2438)	—	4' 4" to 6' 4" (1321-1930)	4' 11" to 6' 11" (1499-2108)
Manual Swing Door	Single	3' to 3' 6" (914-1067)	—	3' 1" to 3' 7" (938-1066)	—
	Pair	5' to 7' (1524-2134)	—	5' 2" to 7' 2" (1574-2184)	—

Revolving Door Systems



Shown: Segmented Drum

Make a Grand Entrance

Achieve impressive architectural appeal and energy efficiency while effectively managing high traffic with Horton's revolving door systems. Expertly engineered, skillfully constructed and rigidly tested to provide the performance and aesthetics you need, Horton revolving doors are available in a variety of finishes, diameters and door wing configurations, with your choice of glazing options, sensors and security features.



Architectural Highlights

- Energy efficient
- Helps maintain consistent lobby temperature
- Compliance with ANSI 156.27 revolving door standard
- Book-fold panels for emergency egress
- Optional bullet-resistant glass with segmented drum or standard curved tempered laminate glass
- Exclusive segmented drum design to utilize flat glass

Revolving Door Traffic Flow

Model	Persons Per Minute
Grand®	40
MiniGrand®	40
AutoFlow®	30
EasyFlow®	15
Visdom ELITE®	12

Comparison

Models	Hospitals/ Healthcare/ Medical	Grocery & Retail	Upscale Residential & Office	Airports	Schools	Hotels/ Resorts	Government Facilities	Industrial Manufacturing	Automatic	Manual	General Traffic	Trained Traffic	3 Wing	4 Wing	Segmented	Round	Safety Sensors	Touchless/Push Activation
Grand®	•	•	•	•		•	•	•	•		•	•	•		•	•	•	•
MiniGrand®	•	•	•	•		•	•		•		•	•	•		•	•	•	•
AutoFlow®	•	•	•	•	•	•	•		•		•	•	•		•	•	•	•
EasyFlow®	•	•	•	•	•	•	•			•	•	•	•	•	•	•		
	MARKETS								FEATURES									

Revolving Door Systems



Grand® Series 9600 Large Diameter Vestibule System

Spacious compartments provide an elegant, energy-efficient entrance up to 16' in diameter to manage high volume traffic including shopping carts, wheelchairs, walkers and even hospital gurneys.



- Smooth, continuous rotation
- Electronic sensing system slows or stops the door when objects are within 8" to 12" of the wings
- Customizable voice enunciator
- One-way security available
- Up to 40 people per minute

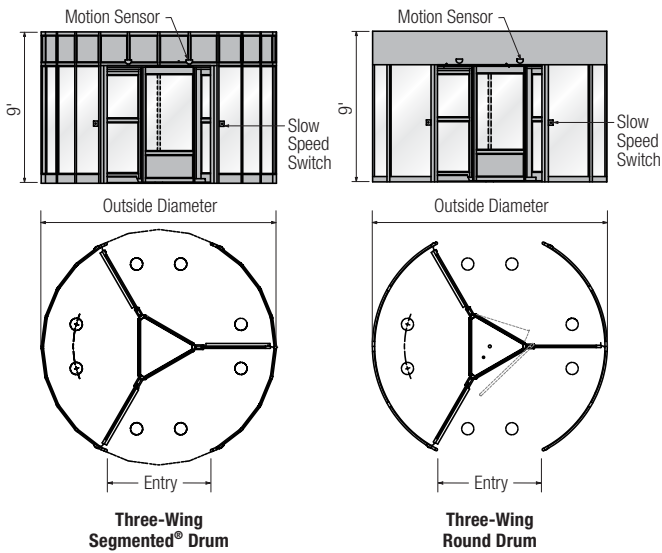

MiniGrand® Series 9300 Automatic Entrance System

The MiniGrand® offers the drum construction of a Grand® with a center shaft in lieu of a core. All options for the Grand® are available with the MiniGrand®, including activation and safety systems.



- Smooth continuous rotation
- Auto rotation with VistaScan™
- Up to 40 people per minute

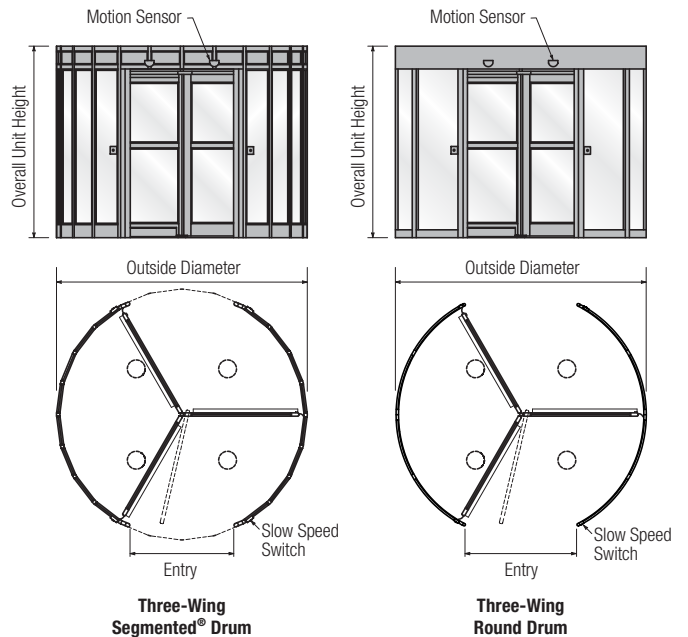

Selection Guide

Model	Type	Outside Diameter	Segmented® Drum Throat Opening	Round Drum Throat Opening
Grand®	Three-Wing	12' to 16' (3658-4877)	5' 3" to 7' 3½" (1619-2229)	5' 1¼" to 7' 1½" (1565-2175)
MiniGrand®	Three-Wing	11' (3353)	4' 9¼" (1467)	4' 7⅞" (1413)
	Three-Wing	12' (3658)	5' 3¾" (1619)	5' 1½" (1565)



AutoFlow® Series 9300

Automatic Entrance System

Hands-free entrance system starts door rotation on user approach. The unit is microprocessor controlled and capable of wireless remote speed adjustment and self-diagnostics.



- 10' diameter
- Three-wing with medium stiles
- Virtually unlimited custom features: finishes, special diameters and heights, ceiling lights and safety features
- Programmable voice messaging
- Up to 30 people per minute

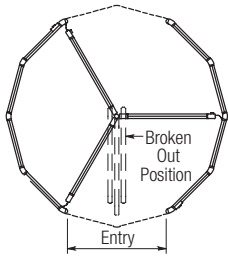
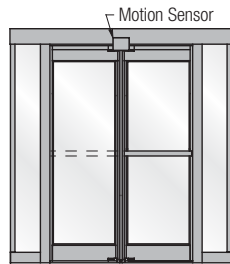
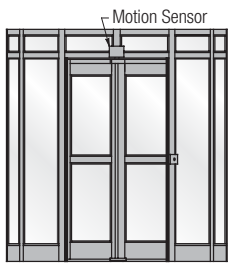

Three-Wing Segmented® Drum

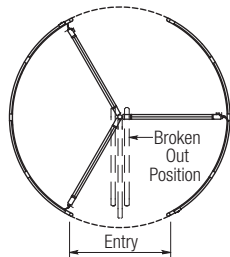

Three-Wing Round Drum



EasyFlow® Series 9500

Manual Door System

An outstanding choice for energy efficiency with architectural appeal, the EasyFlow® series suits any installation requirement. Optional Power Assist available.



- Diameters 6' to 8'
- Push bars or muntins
- Choice of finishes
- Broad range of specifier options including special diameters and heights, electronic speed control and other custom touches
- Up to 15 people per minute

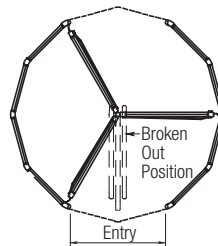
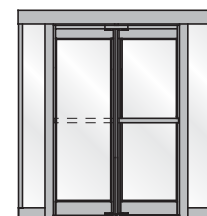
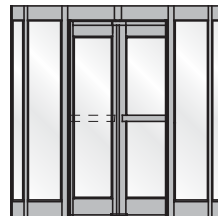

Three-Wing Segmented® Drum

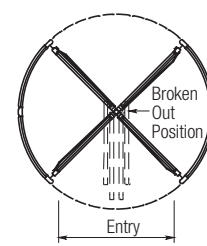

Four-Wing Round Drum

Selection Guide

Model	Type	Outside Diameter	Entry Three Wing	Entry Four Wing
AutoFlow®	Segmented Drum	10' (3048)	4' 4 $\frac{1}{4}$ " (1340)	—
	Round Drum	10' (3048)	—	4' 7 $\frac{7}{8}$ " (1407)
EasyFlow®	Segmented Drum	6' (1829)	—	4' 2 $\frac{1}{8}$ " (1280)
	Segmented Drum	6' 6" (1981)	3' 1 $\frac{1}{2}$ " (918)	4' 6 $\frac{3}{4}$ " (1391)
	Segmented Drum	7' (2134)	3' 3" (991)	4' 11 $\frac{1}{8}$ " (1502)
	Segmented Drum	8' (2438)	3' 9" (1143)	5' 7 $\frac{1}{8}$ " (1724)
	Round Drum	6' (1829)	—	4' 3 $\frac{1}{4}$ " (1238)
	Round Drum	6' 6" (1981)	3' 1 $\frac{1}{2}$ " (918)	4' 5" (1346)
	Round Drum	7' (2134)	3' 3 $\frac{3}{8}$ " (994)	4' 9 $\frac{1}{4}$ " (1454)
	Round Drum	8' (2438)	3' 9 $\frac{1}{2}$ " (1146)	5' 5 $\frac{1}{4}$ " (1670)



EasyFlow® Power Assist Series 9900

Returns to Home Automatically

Manual revolver with Power Assist for speed and noise control. Intelligent RTQP (Return-to-Quarter-Point) system returns wing to home position automatically after pedestrian exit.



- Air lock for energy savings and improved traffic management
- Enhanced air flow and noise control
- Magnetic breakout wings stop in optimal positions during emergencies
- Round or segmented drum and canopy
- Night locks and card access
- Custom ceiling heights to 108" (with recessed lights)

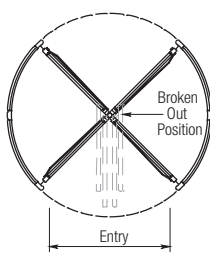
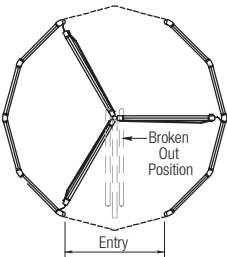
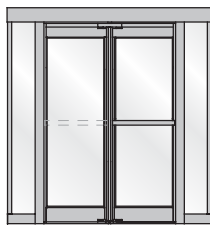

Sensors for Revolving Doors

Sensors are available for directional security and entry protection. Horton ControlFlow®, AutoFlow® and Grand® revolving systems include the appropriate devices for each application.

Most automatic revolving doors include motion detection on both sides for door activation. Additional styles may include a top-of-wing mounted sensor to slow or stop rotation if someone is near the wing. A FootGuard™ infrared sensor for interior/exterior entrance zones and other detection electronics are also common.

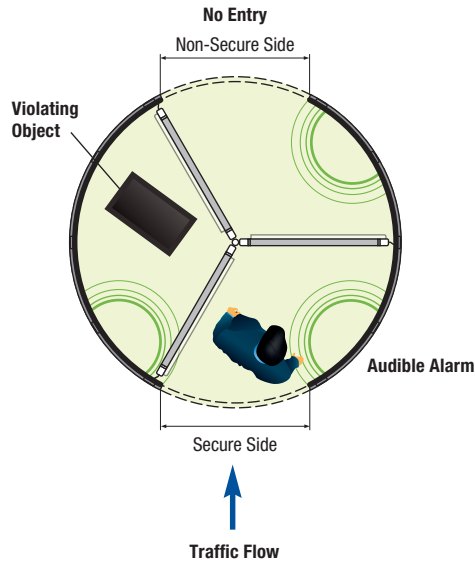

Selection Guide

Model	Series	Type	Inside Diameter	Outside Diameter	Entry	Opening Width	Opening Height
EasyFlow®	Series 9931	3-Wing	6' 6" (1930)	6' 9½" (2070)	3' ⅛" (1918)	6' 10" (2083)	7' 10¼" (2394)
	Series 9930	Segmented or Round	7' 0" (2134)	7' 3½" (2223)	3' 3⅞" (994)	7' 4" (2235)	7' 10¼" (2394)
	Series 9941	4-Wing	6' 0" (1829)	6' 3½" (1918)	4' ¾" (1238)	6' 4½" (1943)	7' 10¼" (2394)
	Series 9940	Segmented or Round	6' 6" (1930) 7' 0" (2134)	6' 9½" (2070) 7' 3½" (2223)	4' 5" (1346) 4' 9¼" (1454)	6' 10½" (2096) 7' 4½" (2248)	7' 10¼" (2394) 7' 10¼" (2394)

Security Revolving Doors



Control and Contain Unauthorized Entrance

Versatile, effective security solutions include bullet-resistant systems and early warning detection devices that restrict pedestrians with malicious intentions.

Applications

- Airport
- Data centers
- Secure centers
- Headquarters

Architectural Highlights

- Security level
- Bullet-resistant glass
- Anti-tailgating
- Anti-piggybacking

Comparison

Models	Hospitals/ Healthcare/ Medical	Grocery & Retail	Upscale Residential & Office	Airports	Schools	Hotels/ Resorts	Government Facilities	Industrial Manufacturing	Automatic	Manual	General Traffic	Trained Traffic	3 Wing	4 Wing	Segmented	Round	Safety Sensors	Touchless/Push Activation	Anti-Tailgate	Anti-piggyback	Visdom Elite	Visdom HS (Object detection)	Ballistic Protection
ControlFlow®	•	•	•	•		•	•	•	•		•	•	•	•	•	•	•	•	•	•	•	•	•
Visdom ELITE®	•	•		•		•	•	•	•		•		•	•	•	•	•	•	•	•	•	•	•
	MARKETS										FEATURES												

□ Optional

Security Revolving Doors



ControlFlow®

Automatic Security Door Systems

Available in One-Way, One-Way Airport and Two-Way Card Access packages, this system has selectable security levels. Add optional Level III bullet-resistant glazing and Visdom HS* advanced 3D piggybacking/tailgating prevention sensors for ultimate protection in banks/financial, government and other high security installations.

- Overhead sensors in place of mats
- Wireless remote setup with 16 modes of operation and programming options
- Field programmable voice messages
- Magnetic breakaway for emergency egress
- Choice of anodized aluminum, paint or metal clad finishes
- Special sizes, extended canopy and other options available



ControlFlow® Two-Way Series 9200

Card Access Security

- Two-way controlled access to secure areas
- The latest sensor technology and biometric or card access
- Continuous flow from both directions simultaneously
- Matless design for superior aesthetics
- Immune to shadows, reflections and environmental changes
- Drum and canopy types

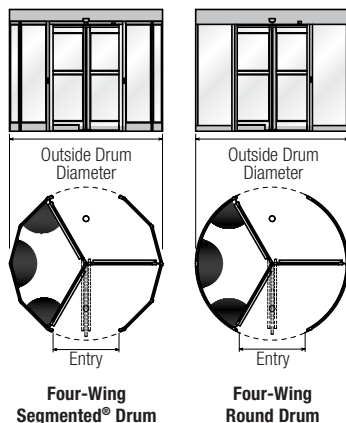

ControlFlow® One-Way Series 9100AP

Airport Security System

- Secure, one-way-only controlled exit
- Three-wing segmented or round drum
- Eliminates the need for a manned station
- Object detection prevents items from being left in the revolving door and rotated to secure areas

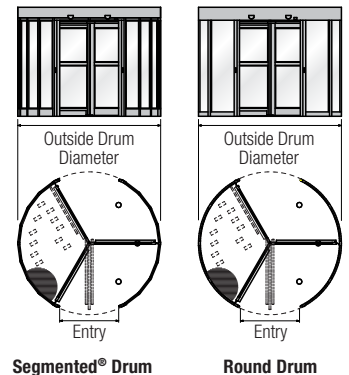

ControlFlow® One-Way Series 9100

Security System

- Free exit with no entry, or restricted entry
- Ideal for transporting pedestrians from secure to nonsecure areas in non-airport applications like pharmaceutical labs
- Three-wing segmented or round drum
- Eliminates the need for manned stations
- Alarms go off and door locks if security is breached

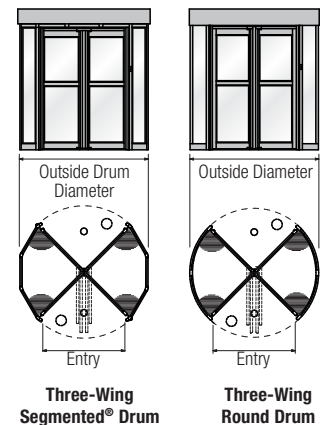

Selection Guide				
Model	Type	Outside Diameter	Segmented® Drum Entry	Round Drum Entry
ControlFlow®	Three-Wing	8' 3½" to 10' 3½" (2527-3137)	3' 4¾" to 4' 4¾" (1026-1330)	3' 6¾" to 4' 6¾" (1089-1394)
ControlFlow® One-Way Airport	Three-Wing	12' (3658)	5' 3¾" (1619)	5' 1¾" (1565)
ControlFlow® Two-Way Anti-Tailgate	Four-Wing	6' 3½" to 7' 3½" (1918-2223)	3' 10" to 4' 6¾" (1168-1391)	3' 10¾" to 4' 7¾" (1191-1406)
ControlFlow® Two-Way Anti-Tailgate/Anti-Piggyback	Four-Wing	6' 3½" to 7' 3½" (1918-2223)	3' 10" to 4' 6¾" (1168-1391)	3' 10¾" to 4' 7¾" (1191-1406)



Visdom ELITE®

Two-Way Matless, Piggyback/Tailgate Prevention Security System

This system detects unauthorized entry violations like piggybacking and tailgating. It discerns between true violations and everyday authorized personnel, which other systems often detect inaccurately.

Customizable Security Levels

The Visdom ELITE® can be set with several modes of operation such as card-in/card-out and card-in/free exit. It also can communicate with card reader systems that use an anti-passback feature.



Easy to Install

Visdom ELITE® installs easily on new or existing door systems. It's compact and self-contained.

- Real time clock (RTC) capable of marking individual events
- Easily retrofits onto existing Horton revolving doors
- Highly Immune to shadows, reflections and environmental changes
- Versatile X or + configuration
- Continuous flow from both directions simultaneously

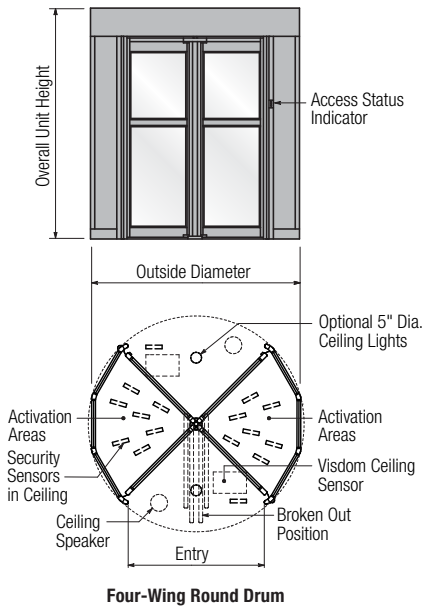
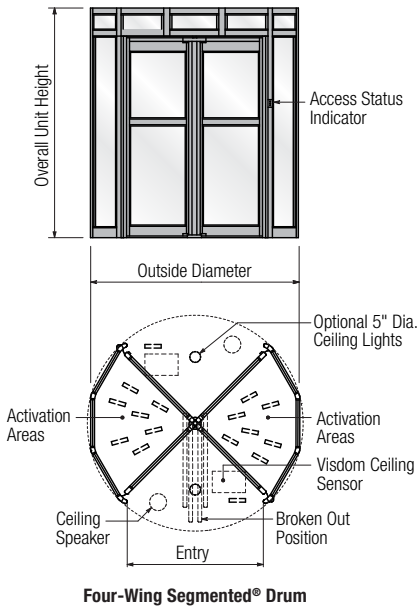

Segmented Canopy
Segmented Drum



Round Canopy
Segmented Drum



Round Canopy
Round Drum

Selection Guide

Model	Type	Outside Diameter	Throat Opening
Visdom ELITE® Round Canopy, Segmented Drum	Four Wing	6' 3½" (1918)	3' 10" (1168)
Visdom ELITE® Round Canopy, Round Drum	Four Wing	6' 9½" (2070)	4' 3½" (1296)

Industrial Sliding Door Systems



Keep Your People and Your Material Flowing

Enhance productivity, make the most of usable floor space, maintain temperatures, improve workplace safety and create separate clean environments with Horton industrial doors.

Architectural Highlights

- Floor mounted guides
- Photoelectric beams placed parallel to the door opening
- Fast-acting HD-Slide® operators for industrial installations
- Operators available for washdown applications

Comparison

Models	Hospitals/ Healthcare/ Medical	Grocery & Retail	Airports	Hotels/ Resorts	Industrial Manufacturing	Commercial/Manufacturing	Automatic	General Traffic	Trained Traffic	Single	Bi-parting	ISO 3 (ISO 14644)	ISO 5 (ISO 14644)	Sensors	Touchless/Push Activation
UltraClean™ Atmospheric I	•				•	•	•	•	•	•	•	•	•	•	•
UltraClean™ Atmospheric II	•	•			•	•	•	•	•	•	•	•	•	•	•
UltraClean™ Sterile	•	•			•	•	•	•	•	•	•	•	•	•	•
Lead-Lined®	•				•	•	•	•	•	•				•	•
RapidSlide®		•	•	•	•	•	•	•	•	•				•	•
HD-Slide® Industrial		•	•	•	•	•	•	•	•	•				•	•
	MARKETS						FEATURES								



RapidSlide® Rugged Steel Door System

Thermacore® insulated steel door assembly has 24" (610 mm) modular sections constructed of metal/foam/metal sandwich for maximum energy efficiency.

- Partial opening for pedestrian traffic
- Full opening for vehicles
- Protects temperature-controlled environments
- R-Values specificable up to 17.5

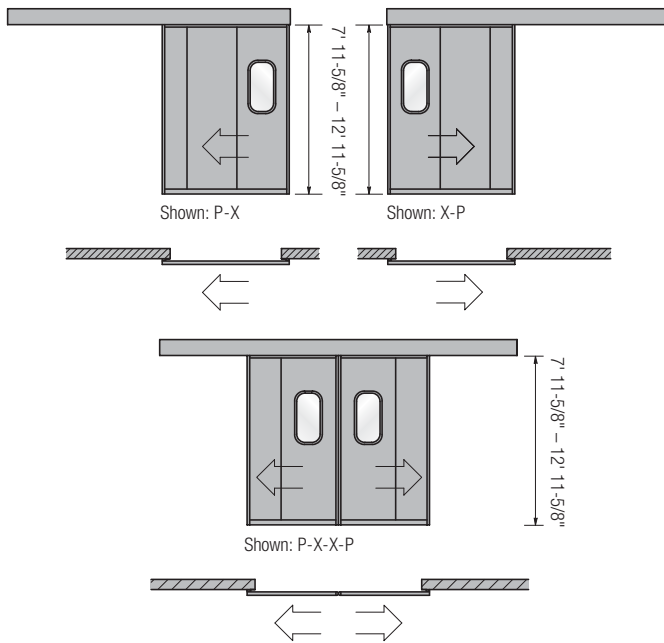

HD-Slide® Industrial with Hollow Metal Panel

Heavy Duty Industrial Door System

Utilizes 18 or 20-gauge galvanized steel skin doors with kraft honeycomb core. Interior framing channels are 14-gauge steel. Panels have a flush appearance with no exposed frames.

Large commercial and industrial applications with oversized door panels

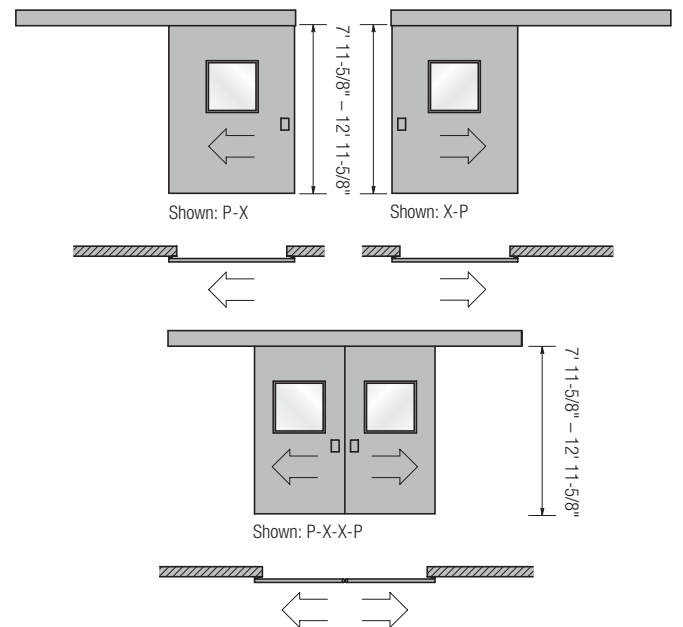

Selection Guide

Model	Type	Unit Width	Max Slide Opening
RapidSlide®	Single	13' 3½" to 25' 3½" (4051-7700)	6' to 12' (1829-3658)
	Bi-Parting	13' 5½" to 25' 5½" (4051-7760)	6' to 12' (1829-3658)
HD-Slide® Industrial with Hollow Metal Panel	Single	6' 8½" to 20' 8½" (2134-6312)	5' to 10' (1524-3048)
	Bi-Parting	13' 5½" to 25' 5½" (4102-7760)	5' to 12' (1524-3658)

Industrial Sliding Door Systems



UltraClean® Atmospheric I ISO 3

Cleanroom, Infection Control & Manufacturing Doors

The UltraClean® Atmospheric I meets ISO 14644 Class 3 applications, without the need for vacuum systems. Available in single slide or bi-parting configurations with partial or full breakout. Units can be surface applied or mounted within a wall opening for a seamless appearance.

Applications

- Semiconductor labs
- Metrology rooms
- Laboratories
- Chemical mixing and packing
- Available in Series 2000 and Series 2021

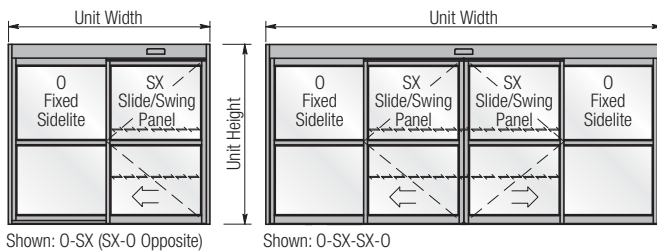

ISO classes specify the maximum concentration limits of a range of particle sizes collected from the cleanroom's air. Refer to table to determine which door fits your specific needs.

Particles/m ³ Particle Size	ISO 3	ISO 5	ISO 9
0.1 µm	1,000	100,000	-
0.2 µm	237	23,700	-
0.3 µm	102	10,200	-
0.5 µm	35	3,520	35,200,000
1.0 µm	8	832	8,320,000
5.0 µm	-	29	293,000

1 µm = 1 millionth of a meter



UltraClean® Atmospheric II ISO 5

Atmospheric Sliding Doors

Designed and tested to meet ISO 14644 Class 5 cleanroom applications, these trackless doors are constructed and rigorously tested. Available in single slide or bi-parting configurations with partial or full breakout. Surface applied or mounted within opening.

Applications

- Cleanroom air showers
- Sterile environments
- Pharmaceutical and healthcare labs
- Chip manufacturing/processing
- Available in Series 2000 and Series 2021

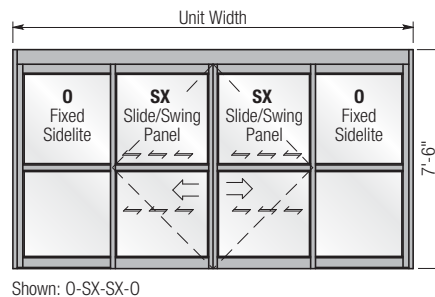
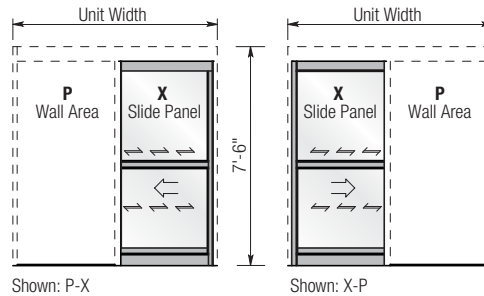

Selection Guide

Mode	Type	Unit Width	Max Slide Opening	Partial Breakout Opening
UltraClean® Atmospheric I & II Series 2000	Single	7' to 9' (2134-2743)	3' to 4' (914-1219)	3' 3/2" to 4' 3/2" (1003-1308)
	Bi-Parting	8' 1" to 16' (2464-4877)	3' 1" to 7' (940-2134)	8' 8" to 7' 7" (2642-2311)
UltraClean® Atmospheric I & II Series 2021	Single	7' to 9' (2134-2743)	2' 11/4" to 3' 11/4" (908-1213)	3' 3/4" to 4' 3/4" (997-1302)
	Bi-Parting	8' to 16' (2438-4877)	3' 1/2" to 7' 1/2" (952-2172)	3' 8/2" to 7' 8/2" (1124-2350)



UltraClean® Sterile Series 2001 Food Preparation

This flush stainless sliding door system is ideal for very low particulate applications such as food processing facilities and withstands frequent washdowns. Available in single or bi-parting configurations, surface applied or mounted within wall opening.

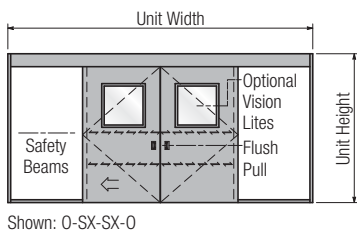
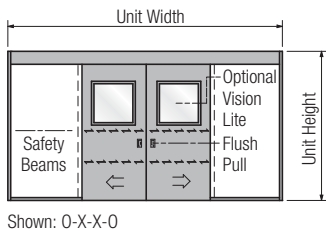
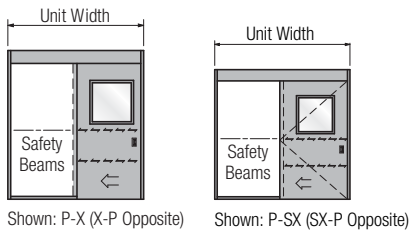

Lead-Lined® X-Ray Room Sliding Door Solutions

These surface-mounted aluminum doors with a structural core are available with a vision lite leaded glass option.

Applications

- Hospitals
- Radiology facilities
- Dental practices
- Doctor offices
- Pharmaceutical
- VA clinics
- Industrial labs

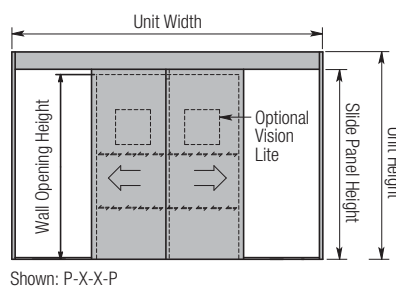
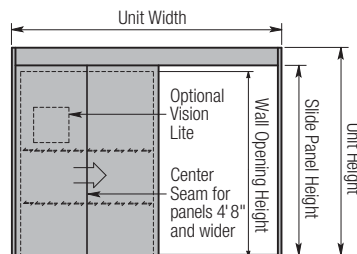

ProSlide® Blast Built To Withstand Explosions

Designed to meet the US Department of Defense Unified Facilities Criteria (UFC) and compliant with anti-terrorism standards, ASTM F2248-03 loading requirements.

- Steel reinforced header and rails
- Heavy-duty 6" by 6" header
- Superior corner block reinforced door panel construction

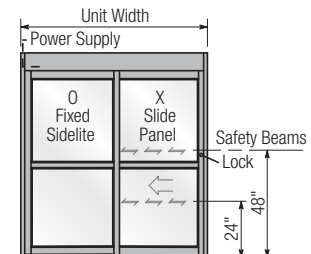

* Bi-Parting styles available up to 14' Unit Width

Selection Guide

Model	Type	Breakout	Unit Width	Max Slide Opening	Breakout Opening
UltraClean® Sterile	Single	None	7' to 9' (2134-2743)	3' to 4' (914-1219)	—
	Single	Partial	7' to 9' (2134-2743)	3' to 4' (914-1219)	3' 3/2" to 4' 3/2" (1003-1308)
	Bi-Parting	None	8' to 16' (2438-4877)	3' to 4' (914-1219)	—
	Bi-Parting	Partial	8' to 16' (2438-4877)	3' to 7' (914-2134)	3' 7" to 7' 7" (1092-2311)
Lead-Lined®	Single	—	7' 1/2" to 13' (2171-4001)	3' to 4' (914-1219)	—
ProSlide® Blast	Single	—	7' (2134)	2' 10/4" (870)	—
	Bi-Parting	—	10' to 14' (3048-4267)	3' 9" to 5' 9/4" (1143-1760)	—

Platform Screen Doors



Custom Transit Solutions

This equipment is installed in public and private transit complexes as an integral part of Automated People Mover (APM) systems.

All systems enhance communication between components that govern operating functions and are designed for long life, dependability and maximum safety per ASC APM Standards.

The barrier wall design option includes all the supporting structure for the platform doors which results in shorter installation time and fewer trades to coordinate.

- Station Platform Screen Doors (PSD)
- Transit System Sliding Doors
- Automatic Train Control (ATC) Monitoring
- Transit Vehicle Door Operators
- Emergency Egress Door (EED)
- Control Panels
- Full Barrier Wall

Call our Transit Solutions Team
for a FREE consultation

1.800.531.3111



Selected Worldwide Installations

- Hartsfield-Jackson International Airport, Atlanta, Georgia
- Heathrow Airport, London, United Kingdom
- Frankfurt am Main Airport, Frankfurt, Germany
- Dulles International Airport, Washington, DC
- Kuala Lumpur International Airport, Sepang, West Malaysia
- Toronto Pearson International Airport, Toronto, Canada
- Beijing Capital International Airport, Beijing, China
- Benito Juarez International Airport, Mexico City, Mexico
- Incheon International Airport, Seoul, South Korea
- Dallas/Fort Worth International Airport, Dallas, Texas
- Las Vegas Monorail, Las Vegas, Nevada



Eliminate Unauthorized Access to a Secure Environment

The Secure Exit Lane (SEL) provides one-way pedestrian traffic from secure to nonsecure zones. The SEL detects, prevents and controls/contains unauthorized traffic while maintaining the natural unhindered flow of authorized pedestrian traffic. With a throughput ten times that of other systems and remote monitoring capability, the SEL also minimizes the need for security personnel.



Architectural Highlights

- Available in single lane, double lane and triple lane
- Five distinct modes of operation
- Remote monitoring eliminates the need for 24/7 security personnel
- Object detection—Unauthorized left-behind objects are detected down to 2" x 2" x 2" in size
- ADA compliant
- Automatic pedestrian traffic detection
- Voice and visual feedback for pedestrians and technical personnel
- Maximum uptime with built-in Uninterruptible Power Supply (UPS)
- Bullet-resistant glass option

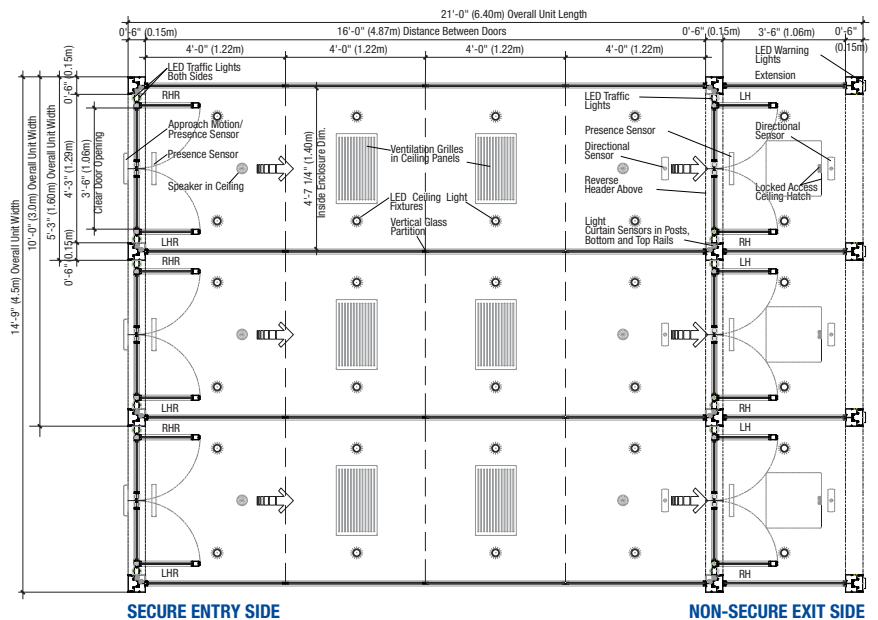
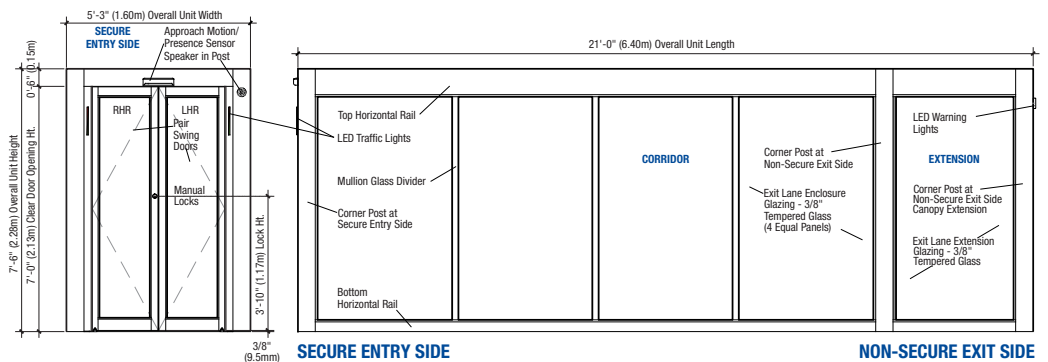

Service Windows



Drive-Thru Service Windows

Horton's service windows are standard equipment for leading restaurant chains, pharmacies and other companies. Units can be up to 1" insulated glass and with a variety of counter tops such as stainless steel and other specified options. The windows open and close automatically when activated by Horton's HipScan™ or WinScan™ and can also be opened manually. An optional automatic lock secures the window each time it closes.

- Auto-close and reverse-on-contact functions
- Maximum security lock
- Fully assembled and glazed for easy installation
- Available in anodized aluminum, paint and metal-clad finishes
- Bullet-resistant glass option

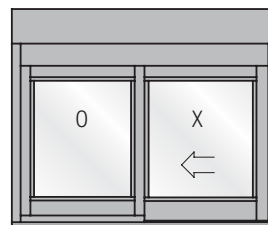
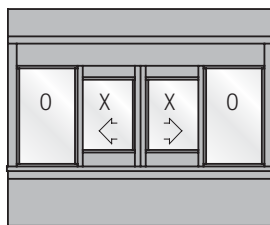
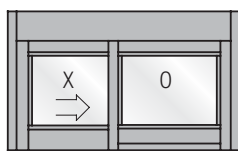
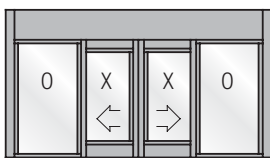

Sensors for Swinging Doors and Folding Doors

Sensor packages include systems with varying degrees of detection. Basic systems incorporate a microwave or active infrared sensor on the approach side with presence sensors and infrared photo beams on the swing side. Enhanced systems add door-mounted presence sensors to each side of the swinging door. Guide rails are normally specified on the swing side (or fold side of the folding doors) per ANSI A156.10. Two rails are required if a wall or barrier is not present.

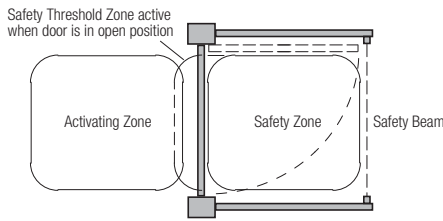

Swinging Doors

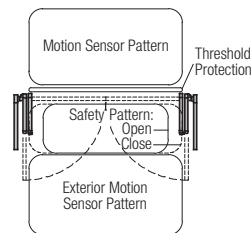

Bi-folding Doors



Selection Guide			
Model	Part Number	Description	Type
Fully Automatic Vista Sensor System (ANSI 156.10)	C1884 or C1234	Choice of Microwave Motion Sensor OR Active Infrared Motion/Presence Sensor	Activation
	C1829	Active Infrared Sensor	Safety
	C7783	Photo Beam (Wall or Guide Rail Mounted)	Safety
	C1878-2	Door Mounted Presence Sensor (Each Side of Door)	Safety
Knowing Act	C1829	Infrared Presence Detection	Optional Safety
Low Energy Activation and Safety Options (ANSI 156.19)	C7783	Safety Beam Set	Optional Safety
	C1260-5*	4 1/2" x 4 1/2" Stainless Steel Switch	Optional Activation
	C1260-5RC*	4 1/2" x 4 1/2" Wireless Stainless Steel Switch	Optional Activation

*Both with international handicap logo

Sensors for Sliding Doors

All dual systems utilize infrared reflective and/or microwave sensing on both sides for two-way traffic activation. In addition, Horton includes photo beam sensors mounted in the sidelite or frame at 24" and 48" from the floor to prevent closure when a pedestrian is in the opening.

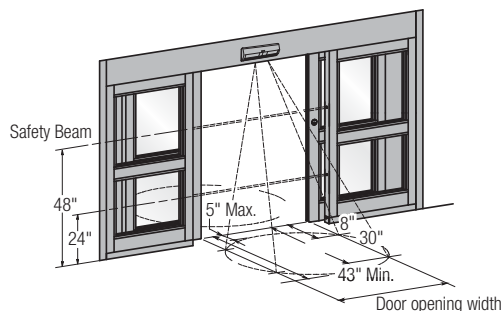

Note: All safety sensors are self-monitoring per the ANSI A156.10 standard.

Selection Guide			
Model	Part Number	Description	Type
Sensors	C1827**	Microwave Motion/Active Infrared Presence	Optional – Activation/Safety
	C1238**	Active Infrared Motion/Presence	Optional – Activation/Safety
	C7775	Dual Transmitter/Receiver Photo Beams	Redundant Safety

**A standard sliding door system features a pair of either of these sensors

Activating Switches

- Round or square metal push plates
- Push-button
- Keyless digital-code entry
- Key switch
- Electric mat
- Touchless photoelectric wall switch
- Explosion-proof solid state switch
- Touchless sensors
- Fingerprint, retina, face ID

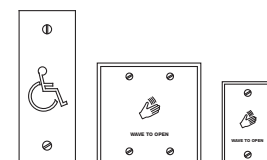
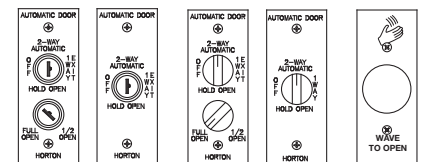
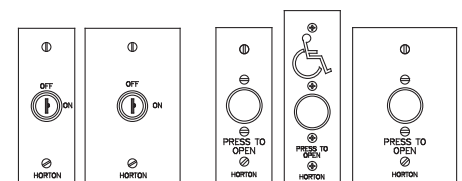

Door Selection Tools



COMPARE

Door Comparison Charts

Review Horton door features at a glance in these handy charts.

- Sliding Door Systems [page 7](#)
- Swing & Folding Door Systems [page 16](#)
- Revolving Door Systems [page 23](#)
- Security Revolving Door Systems [page 27](#)
- Industrial Sliding Door Systems [page 30](#)



BROWSE

Interactive Product Selection Guide

Quickly navigate through Horton.com products, specifications and application information using this easy interactive tool.

www.hortondoors.com/ProductGuide



CHOOSE

DoorGenius™

Quickly receive a general idea of the type of door you need for a project using this simple online tool.

www.hortondoors.com



SPECIFY

SpecGenius™

Find the exact door you need, automatically generate a spec, find detailed product information, customization options, save and organize projects on this user-friendly interface.

genius.hortondoors.com



CONNECT

Spec Desk

Get in touch with our in-house spec consultants at 1.800.531.3111 or specs@hortondoors.com



Professional Installation and Service



Horton brings you the professional support of factory-authorized distributors. All Horton systems are built to exceed applicable quality and safety standards including:

- ANSI standards for pedestrian doors (A156.10, A156.19, A156.38, A156.27)
- 1990 ADA requirements for barrier-free entrances
- Tested to UL 1784 to meet National Fire Protection Association (NFPA) regulations on select products
- National building codes related to emergency exit
- American Testing Laboratory ratings for wind load and forced entry on select products
- CSA, IBC, Miami-Dade, BOCA and other regional requirements on select products
- Listed by Intertek (ETL) for compliance to UL 325 Electrical Door, Drapery, Gate, Louver and Window Operators and Systems

Call your Horton distributor today for design, specification and application assistance.

Visit www.hortondoors.com to find a [distributor near you](#).

Specify Horton and demand AAADM certified installation.

AAADM American Association of
Automatic Door Manufacturers



Horton Pedestrian Access Solutions

- Horton Automatics®
- FLEX™ by Horton
- Door Services Corporation®
- Won-Door®

Horton Automatics

World Headquarters
4242 Baldwin Boulevard
Corpus Christi, Texas 78405-3399 USA
Phone: 800-531-3111, 361-888-5591
Fax: 361-888-6510

www.hortondoors.com

Overhead Door Corporation

A Sanwa Holdings Company